

## FLEXIDOME panoramic 5100i IR



- ▶ 360° panoramic overview in 6MP and 12MP sensor resolution without blind spots
- ▶ Optimized for all lighting conditions with integrated IR and High Dynamic Range
- ▶ Edge or client-side dewarping for easy integration and flexible viewing and recording
- ▶ Built-in Intelligent Video Analytics and Intelligent Audio Analytics to trigger relevant alerts and quickly retrieve data
- ▶ Compact design protected against vandalism and all weather conditions

The FLEXIDOME panoramic 5100i IR is a discreet and aesthetic panoramic camera for indoor and outdoor surveillance.

Its stereographic, panoramic lens provides full 360° coverage without blind spots, ideal for surveillance applications that require wide area coverage in a single, detailed view. The camera offers full situational awareness and simultaneous high-resolution zoomed-in images. The high-end system on chip (SoC) provides dewarping for easy integration and flexible viewing and recording.

Built-in Intelligent Video Analytics enriches full situational awareness and triggers relevant alerts. Intelligent Audio Analytics gives meaning to the sounds it captures.

The camera's integrated IR provides the flexibility to control IR intensity in multiple zones to prevent IR saturation. Additionally, with its wide range of inputs and outputs, such as Alarm and HDMI, it can be used for any application.

The camera has an IK10 and IP66 design to protect itself against vandalism and all weather conditions.

### Functions

#### Up to 12MP sensor resolution

The camera offers a choice between a 6MP or 12MP sensor to optimize for the amount of details required. Both options offer 30 fps to ensure real-time motion in your scenes.

Taking into account the image circle projection, the cameras offer a 4.5MP and 9MP effective resolution. Combined with the stereographic lens in these cameras it also provides improved resolution in the peripheral areas of the image.

#### Panoramic vision and Intelligent Video Analytics

Combining Bosch Intelligent Video Analytics software with full panoramic vision, produces an extremely powerful surveillance tool, which enriches full situational awareness. With intelligent tracking, movement can be followed continuously throughout the full image circle. There is no need to hand off tracking from one camera to another, greatly simplifying movement analysis.

The system reliably detects, tracks, and analyzes objects, and alerts you when predefined alarms are triggered. A smart set of alarm rules makes complex tasks easy and reduces false alarms to a minimum. Moving objects can be classified in four different object classes: person, car, bike, truck. Specifically designed for the most demanding environments. It is extremely resistant to false triggers caused by challenging environments with snow, wind (moving trees), rain, hail, and water reflections. Calibration is quick and easy - just enter the mounting height of the camera. The internal gyro/accelerometer sensor provides the rest of the information to precisely calibrate the video analytics.

### Camera Trainer

Based on examples of target objects and non-target objects, the Camera Trainer program uses machine learning to allow the user to define objects of interest and generate detectors for them. In contrast to the moving objects that the Intelligent Video Analytics application detects, the Camera Trainer program detects both moving and non-moving objects and classifies them immediately. Using Configuration Manager, you can configure the Camera Trainer program using both live video as well as recordings available through the respective camera. The resulting detectors can be downloaded and uploaded for distribution to other cameras.

A free of charge license is required to activate the Camera Trainer program.

### Intelligent Audio Analytics

The device has an integrated microphone array with three digital microphones for Intelligent Audio Analytics. This is a powerful AI-driven audio signal processing algorithm built to detect and identify target sounds from the ambient sound. It is powered by SoundSee technology and developed to improve operations of the International Space Station (ISS). A set of sound detectors identify sound events such as gunshot and T3 / T4 alarms. The sound detectors trigger an alarm functionality to alert the operator when the sound event matches an audio signature of a sound detector. Without the need to record audio, Intelligent Audio Analytics generates metadata that is seamlessly integrated with Bosch' Intelligent Video Analytics metadata stream.

The device is not only able to classify sounds, but also to provide an approximate location of the sound. If required by local laws, the microphone can be permanently blocked via a secure license key. As Intelligent Audio Analytics is under development, the available Sound Detectors and features will dependent on the camera FW version.

### Dewarping

The lens captures a circular image. Our dewarping software transforms this circular image into several different distortion-free rectangular views. To facilitate system integration, you can choose edge dewarping inside the camera or client-side dewarping on an external platform.







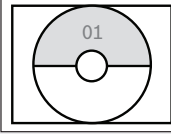
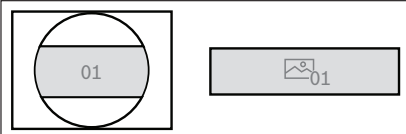
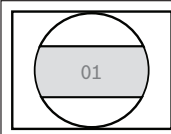
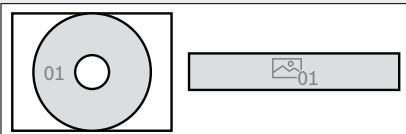
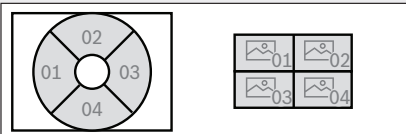
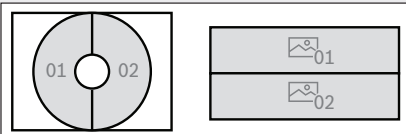
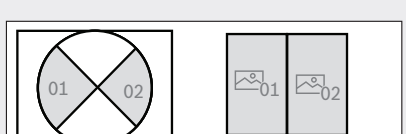

The edge dewarping in the camera provides three separate video channels simultaneously:

- Full image circle (Video 1 channel)
- Dewarped view mode (Video 2 channel)
- E-PTZ (Video 3 channel)

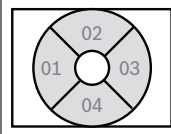
Different view modes can be selected for the video 2 channel. Your selection depends on the resolution you require and how you wish to view the dewarped image.

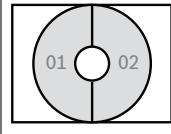
### View modes

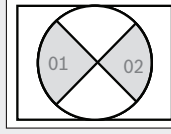
The following view modes can be select in the camera or on the client:

	Full image cut-out and displayed image	
Panoramic view (ceiling mount)		
Panoramic view (for 180° wall mount)		
E-PTZ view		
Full panoramic view		
Quad view		
Double panoramic view		
Corridor view (ceiling mount)		

### Video output for HDMI devices

The camera has HDMI output up to 1080p resolution for live streaming to a public view monitor, ideal for retail usage or for local video display. Via its micro HDMI connector, the camera can display the full image circle.

It also offers the flexibility to display both warped and dewarped images, including quad view and ePTZ.

**High Dynamic Range**

The camera has High Dynamic Range. This is based on a multiple-exposure process that captures more details in the highlights and in the shadows even in the same scene. The result is that you can easily distinguish objects and features, for example, faces with bright backlight.

The actual dynamic range of the camera is measured using Opto-Electronic Conversion Function (OECF) analysis according to IEC 62676 Part 5. This method is used to provide standardized measurements, which can be used to compare different cameras.

**DORI coverage**

DORI (Detect, Observe, Recognize, Identify) is a standard system (EN-62676-4) for defining the ability of a person viewing the video to distinguish persons or objects within a covered area. The maximum distance at which a camera/lens combination can meet these criteria is shown below:

When mounted at 3 m (10 ft) height the camera has the following coverage radius for the four DORI levels for a person in the scene:

DORI	DORI definition	Coverage radius
Detect	25 px/m (8 px/ft)	12MP: 45.5 m / 149 ft 6MP: 28 m / 93 ft
Observe	63 px/m (19 px/ft)	12MP: 18 m / 60 ft 6MP: 11.5 m / 38 ft
Recognize	125 px/m (38 px/ft)	12MP: 8.5 m / 28 ft 6MP: 5.5 m / 18 ft
Identify	250 px/m (76 px/ft)	12MP: 3.8 m / 13 ft 6MP: 2.1 m / 7 ft

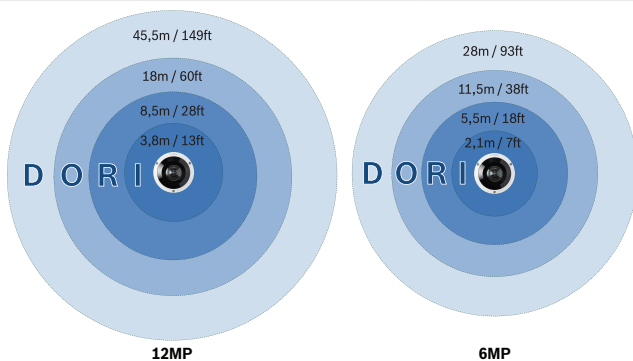

**E-PTZ and regions of interest**

The remote E-PTZ (Electronic Pan, Tilt and Zoom) controls allow you to select specific areas of the full image circle. With onboard dewarping enabled, these Regions of Interest (ROI) can be easily defined, allowing the most interesting part of a scene to be monitored separately. The high resolution ensures that details are not lost even when using the electronic zoom.

The E-PTZ feature of a panoramic camera has some advantages over normal PTZ cameras. There is no camera movement so the camera does not draw attention to itself or appear intrusive. Situational awareness is still retained even when zooming in on a particular object of interest. The smooth E-PTZ function helps navigation, and presets are available for setting up a guard tour.

Intelligent tracking is also available to track people through the entire view of the camera.

**Record exactly what you want**

The camera provides the full resolution circular image for recording even if you are viewing only a portion of the scene. This means that you can always perform retrospective dewarping and analysis on the complete area covered and then zoom in on the region or object of interest.

With edge-dewarping you can also choose to only record the relevant parts of the scene which helps reduce bitrates significantly.

**Scene modes**

The camera has a very intuitive user interface that allows fast and easy configuration. Multiple preset configurable modes are provided with the best settings for a variety of applications. Different scene modes can be selected for different situations, such as sodium lighting or dark environments.

**Edge recording**

Insert a memory card into the card slot to store up to 2 TB of local alarm recording. Pre-alarm recording in RAM reduces recording bandwidth on the network, and extends the effective life of the memory card. It has advanced edge recording providing a reliable storage solution possible due to the combination of these functions:

- Industrial SD card support allows for extreme lifetime
- Health monitoring of industrial SD cards provide early service indications.

Health monitoring will be available with a future firmware version.

**Data security**

Special measures have been put in place to ensure the highest level of security for device access and data transport. The three-level password protection with security recommendations allows users to customize device access. Web browser access can be protected using HTTPS and firmware updates can also be protected with authenticated secure uploads. The cameras have built-in Secure Element (SE) hardware providing main Trusted Platform Module (TPM) functionality to ensure the highest levels of data security and privacy protection. Together with Public

Key Infrastructure (PKI) support, superior protection from malicious attacks is guaranteed. It also supports 802.1x network authentication with EAP/TLS and RSA encryption key lengths of up to 4096 bits, ensuring data safety beyond 2030. The advanced certificate handling offers:

- Bosch origin device certificate pre-installed
- Self-signed unique certificates automatically created when required
- Client and server certificates for authentication
- Client certificates for proof of authenticity
- Certificates with encrypted private keys

### Modular accessories

A full line of modular accessories is available that allows a consistent design across different cameras and a wide range of installation possibilities. Available options include wall or pipe mount, a surveillance cabinet with power and fiber optic options. There is also a conduit adapter available for installations on concrete walls or ceilings.

### H.265 high-efficiency video encoding

The camera is designed on the most efficient and powerful H.264 and H.265/HEVC encoding platform. The camera is capable of delivering high-quality and high-resolution video with very low network load. With a doubling of encoding efficiency, H.265 is the compression standard of choice for IP video surveillance systems.

### System integration and ONVIF conformance

The camera conforms to the ONVIF Profile S, ONVIF Profile G, ONVIF Profile M, and ONVIF Profile T specifications. For H.265 configuration, the camera supports Media Service 2, which is part of ONVIF Profile T. Compliance with these standards guarantees interoperability between network video products regardless of manufacturer. Third-party integrators can easily access the internal feature set of the camera for integration into large projects. Visit the Bosch Integration Partner Program (IPP) website ([ipp.boschsecurity.com](http://ipp.boschsecurity.com)) for more information.

### Cloud-based services

The camera supports time-based or alarm-based JPEG posting to four different accounts. These accounts can address FTP servers or cloud-based storage. Video clips or JPEG images can also be exported to these accounts.

Alarms can be set up to trigger an e-mail or SMS notification so you are always aware of abnormal events.

### Bosch Remote Portal

With the secure cloud infrastructure, Bosch Remote Portal, you can manage your connected Bosch devices. From the Bosch Remote Portal you can:

- Complete initial configuration of your connected Bosch devices (online or offline).
- Update firmware for single or multiple devices.
- Manage certificates.
- Monitor the health of your connected Bosch devices.

### Two-way audio and built-in microphone

Two-way audio allows the operator to communicate with visitors or intruders via an external audio line input and output. Alternatively, there is an integrated microphone to capture crisp and clear audio. By using the integrated or external microphone, audio detection can be used to generate alarms to alert the security operator quicker and act more proactively. If required by local laws, the microphone can be blocked via a secure license key.

### Resists rain, dust, and tampering with reliable operation across a wide temperature range

Suitable for indoor and outdoor usage.

The robust design of the camera is rated to IP66 and IK10 standards, safeguarding the camera against rain and dust while also offering protection against vandalism and tampering.

The camera can operate in a wide ambient temperature range between -40 °C up to +55 °C / -40 °F up to 131 °F.

### Regulatory information

Standards	Type
Emission	EN 55032 EN 50121-4 CFR 47 FCC part 15, Class A
Environmental	EN IEC 63000: 2018 EN 50130-5: 2011 RoHS EU, 2011/65/EU and 2015/863/EU WEEE EU, 2012/19/EU NEMA TS-2 chapter 2.1
Immunity	EN 50130-4
Marks	CE, FCC, UL, WEEE, RCM, VCCI, CMIM, UKCA, China RoHS, BIS
Safety	EN 62368-1 EN 60950-22 UL 60950-22 UL 62368-1, 2nd edition

Standards	Type
	CSA C22.2 No. 62368-1-14, 2nd edition
Image performance	IEC 62676-5
ONVIF conformance	EN 50132-5-2, EN 62676-2
Impact protection	EN 62262 (IK10)
Ingress protection	EN 60529 (IP66) and UL50E (NEMA Type 4X)
IR lighting	IEC 62471

Region	Regulatory compliance/quality marks	
Great Britain	UKCA	
USA	UL-CAP	Cybersecurity Assurance Program
Global	IEC_62443	Industrial Cyber Security Capability
Europe	CE	

**Installation/configuration notes**

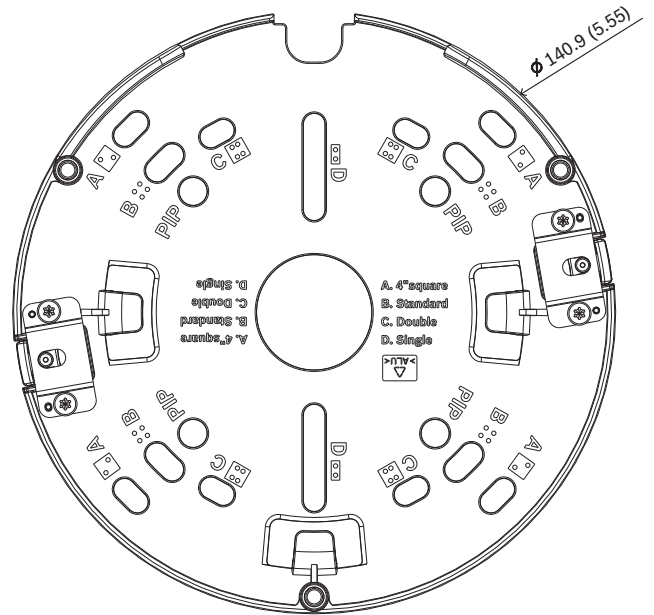
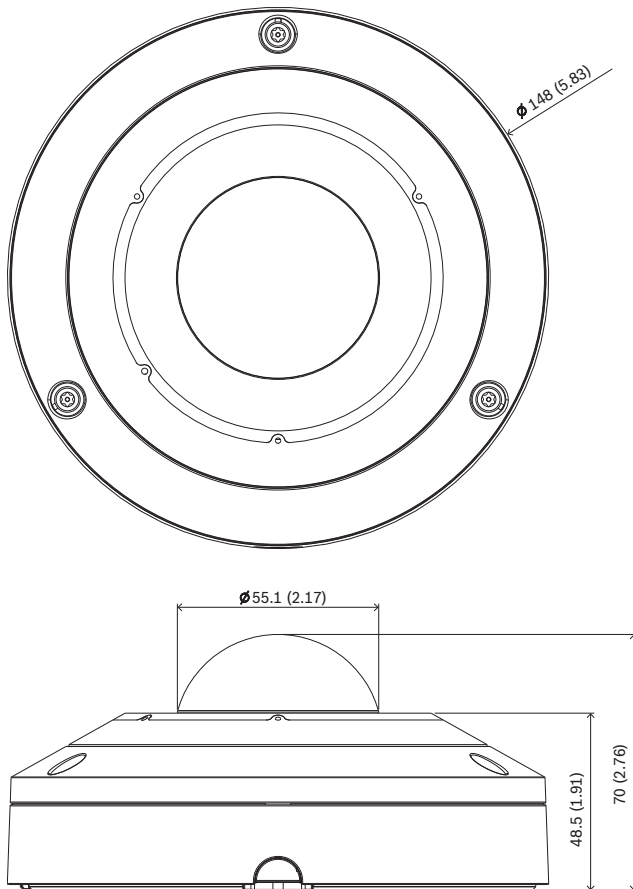

Dimensions in mm (inch)

**Technical specifications**

Power	
Input voltage	PoE IEEE 802.3af / 802.3at Type 1, Class 3 24 VAC ±10% 12 VDC ±10% PoE and auxiliary power can be connected simultaneously for redundant operation
Power consumption (typical / maximum)	5.6 / 11.4 W

Sensor	
Total sensor pixels	6 MP
Type (6 MP)	1/1.8-inch CMOS
Used pixels (6 MP)	2112 x 2112 (4.5 MP)
Total sensor pixels	12 MP
Type (12 MP)	1/2.3 inch CMOS
Used pixels (12 MP)	3008 x 3008 (9 MP)

Video performance - Sensitivity	
Measured according to IEC 62676 Part 5 (1/25, F2.0)	
Color (6 MP)	0.099 lx
Mono (6 MP)	0.008 lx
With IR (6 MP)	0 lx
Color (12 MP)	0.150 lx

**Video performance - Sensitivity****Measured according to IEC 62676 Part 5 (1/25, F2.0)**

Mono (12 MP)	0.048 lx
With IR (12 MP)	0 lx

**Video performance - Dynamic range**

Wide Dynamic Range (6 MP)	120 dB WDR
---------------------------	------------

Measured according to IEC 62676 Part 5 (6 MP)	105 dB WDR
---	------------

Wide Dynamic Range (12 MP)	120 dB WDR
----------------------------	------------

Measured according to IEC 62676 Part 5 (12 MP)	106 dB WDR
--	------------

**Video streaming**

Video compression	H.265; H.264; M-JPEG
-------------------	----------------------

Streaming	Multiple configurable streams in H.265, H.264 and M-JPEG, configurable frame rate and bandwidth. Multiple channels with edge dewarping. Regions of Interest (ROI)
-----------	---

Overall IP Delay	Min. 120 ms, Max. 340 ms
------------------	--------------------------

GOP structure	IP, IBP, IBBP
---------------	---------------

Frame rate (6 MP)	1-30fps
-------------------	---------

Frame rate (12 MP)	1-30fps 1-25fps in HDR mode
--------------------	--------------------------------

Encoder regions	Eight independent areas for setting encoder quality to optimize bitrate.
-----------------	--

**Video resolution (H x V)**

Video 1 channel	Full image circle	6 MP: 2112 x 2112 (4.5 MP) 12 MP: 3008 x 3008 (9 MP)
-----------------	-------------------	---

Video 2 channel	Various dewarped modes (Full panoramic, double panoramic, quad, corridor, E-PTZ)	Resolution depends on selected dewarped mode
-----------------	--	--

Video 3 channel	E-PTZ	Up to 1280 x 720
-----------------	-------	------------------

**Video resolution (H x V)**

Multiple lower resolutions available and individually selectable per channel and stream

**Video functions**

Day/Night	Color, Monochrome, Auto (adjustable switchover points)
-----------	--

Adjustable picture settings	Contrast, Saturation level and control, Brightness, Sharpness
-----------------------------	---

White Balance	2500 to 10000K, 3 automatic modes (Basic, Standard, Sodium vapor), Manual mode and Hold mode
---------------	--

Shutter	Automatic Electronic Shutter (AES) Default shutter (1/30 [1/25] to 1/500) selectable Max. shutter speed 1/1.875 to 1/150000
---------	---

Backlight compensation	Off / On
------------------------	----------

Noise reduction	Dynamic Noise Reduction
-----------------	-------------------------

Privacy Masking	Eight independent areas, fully programmable
-----------------	---

Scene modes	Multiple default modes with scheduler
-------------	---------------------------------------

Pre-positions	Six independent sectors
---------------	-------------------------

Display stamping	Individual names and stamps for all video channels
------------------	--

Other functions	Pixel counter, Video watermarking, Location
-----------------	---

**Video content analysis**

Analysis type	Intelligent Video Analytics, Camera Trainer
---------------	---

Alarm rules (combinable)	Any object, Object in field, Line crossing, Enter / leave field, Loitering, Follow route, Idle / removed object, Counting, Occupancy, Crowd density estimation, Condition change, Similarity search, Flow / counter flow
--------------------------	--

Object filters	Duration, Size, Aspect ratio, Speed, Direction, Color, Object classes (4)
----------------	---

Tracking modes	Standard (2D) tracking, 3D tracking, 3D people tracking, Ship tracking, Museum mode
----------------	---

Object classes	Person, car, bike, truck
----------------	--------------------------

Calibration / Geolocation	Automatic, based on gyro sensor and camera height
---------------------------	---

Video content analysis	
Audio AI	Gunshot detection, glass-break detection, loud noises detection (available with a future firmware version)
Night vision	
Distance	20 m (66 ft)
LED	360° LED high efficiency array, 850 nm
IR intensity	5 controllable zones
Optical	
Lens	1.155 mm fixed-focus lens F2.0 (6 MP) 1.26 mm fixed-focus lens F2.0 (12 MP)
Lens mount	Board mounted
Iris control	Fixed iris
Day/Night	Switchable IR-cut filter
Field of view	182° (H) x 182° (V)
Minimum object distance	0.1 m
Local storage	
Internal RAM	5 s pre-alarm recording
Memory card slot	Micro SDXC / SDHC / SD card
Industrial SD cards	Extreme lifetime and health monitoring support (if supported by the SD card) that provides early service indication. Health monitoring will be available with a future firmware version.
Input/output	
Audio line in	0.707 Vrms max, 10 kOhm typical
Audio line out	0.707 Vrms at 16 Ohm typical
Alarm input	1 input
Alarm input activation	Short or DC 5V activation
Alarm output	1 output
Alarm output voltage	30 VDC, max. load 0.5 A
Video output for HDMI-compatible devices	Micro HDMI connector and 1080p resolution with dewarped viewing possibilities

Input/output	
Microphone	Integrated array with 3 digital MEMS audio sensors
Ethernet	RJ-45
Fiber optics (sold separately)	The Fiber Optic Ethernet Media Converter kit (VG4-SFPSCKT) installed inside a Surveillance Cabinet (NDA-U-PA0, NDA-U-PA1 or NDA-U-PA2) provides the fiber optic interface to the mounted camera.
Audio streaming	
Standard	G.711, 8 kHz sampling rate L16, 16 kHz sampling rate AAC-LC, 96 kbps at 32/48 kHz sampling rate
Signal-to-Noise Ratio	>50 dB
Audio Streaming	Full-duplex / half duplex
Platform	
Common product platform	CPP14
Data security	
Secure Element ("TPM")	RSA 4096 bit, AES/CBC 256 bit
PKI	X.509 certificates
Encryption	Full end-to-end encryption with supported VMS Network: TLS1.0/1.1/1.2/1.3, AES128, AES256 Local storage: XTS-AES
Video authentication	checksum, MD5, SHA-1, SHA-256
Firmware protection	Signed firmware, secure boot
Network	
Protocols	IPv4, IPv6, UDP, TCP, HTTP, HTTPS, RTP/RTCP, IGMP V2/V3, ICMP, ICMPv6, RTSP, FTP, ARP, DHCP, APIPA (Auto-IP, link local address), NTP (SNTP), SNMP (V1, V3, MIB-II), 802.1x, DNS, DNSv6, DDNS (DynDNS.org, selfHOST.de, no-ip.com), SMTP, iSCSI, UPnP (SSDP), Diff-Serv (QoS), LLDP, SOAP, CHAP, digest authentication
Ethernet	10/100/1000 Base-T, auto-sensing, half/full duplex
Connectivity	Auto-MDIX

Network	
Interoperability	ONVIF Profile S ONVIF Profile G ONVIF Profile M ONVIF Profile T
Mechanical	
Dimensions (Ø x H)	148 x 70 mm (5.83 x 2.76 in)
Lens adjustment (rotation)	355°
Weight	0.82 kg (1.81 lbs)
Color	White (RAL9003)
Gyrosensor	Yes
Dome bubble	Polycarbonate, clear with UV blocking anti-scratch coating
Housing	Aluminum with dehumidifying membrane and waterproof connection area
Mounting	Mounting plate included for surface mount, 4-inch square junction box, single and double gang box
Conduit	Compatible with conduit back box for 3/4-inch NPT (M25) conduit side entry (sold separately)
Environmental	
Operating temperature	IR on: -40 °C to +50 °C (-40 °F to 122 °F) IR off: -40 °C to +55 °C (-40 °F to 131 °F)
Storage temperature	-40 °C to +70 °C (-40 °F to 158 °F)
Operating humidity	5% to 93% RH non-condensing 5% to 100% RH condensing
Storage humidity	Up to 98% RH
Impact protection	IK10
Ingress protection	IP66 and NEMA Type 4X
Sustainability	PVC free
Country of origin	NDS-5703-F360LE/NDS-5704-F360LE: Thailand NDS-5703-F360LE-GOV/NDS-5704-F360LE-GOV: Taiwan

## Ordering information

### NDS-5703-F360LE Fixed dome 6MP 360° IP66 IR

360° 6MP panoramic camera with HDR, IVA, microphone array for Intelligent Audio Analytics, video output for HDMI-compatible devices, H.265, vandal and weather protection

NDAA compliant

Order number **NDS-5703-F360LE | F.01U.385.630**

### NDS-5704-F360LE Fixed dome 12MP 360° IP66 IR

360° 12MP panoramic camera with HDR, IVA, microphone array for Intelligent Audio Analytics, video output for HDMI-compatible devices, H.265, vandal and weather protection

NDAA compliant

Order number **NDS-5704-F360LE | F.01U.385.631**

### NDS-5703-F360LE-GOV Fixed dome 6MP 360° IP66 IR Gov

360° 6MP panoramic camera with HDR, IVA, microphone array for Intelligent Audio Analytics, video output for HDMI-compatible devices, H.265, vandal and weather protection

NDAA and TAA compliant

Available in North America only

Order number **NDS-5703-F360LE-GOV | F.01U.405.544**

### NDS-5704-F360LE-GOV Fixed dome 12MP 360° IP66 IR Gov

360° 12MP panoramic camera with HDR, IVA, microphone array for Intelligent Audio Analytics, video output for HDMI-compatible devices, H.265, vandal and weather protection

NDAA and TAA compliant

Available in North America only

Order number **NDS-5704-F360LE-GOV | F.01U.405.545**

## Accessories

### NDA-5080-PIP Pendant interface plate, 148mm

Pendant interface plate for FLEXIDOME indoor 5100i, FLEXIDOME indoor 5100i IR, and FLEXIDOME panoramic 5100i IR

Order number **NDA-5080-PIP | F.01U.389.607**

### NDA-5080-PIPW Pendant interface plate, 148mm

Pendant interface plate with weather cap for FLEXIDOME panoramic 5100i IR

Order number **NDA-5080-PIPW | F.01U.394.003**

### NDA-U-WMT Pendant wall mount

Universal wall mount for dome cameras, white

Order number **NDA-U-WMT | F.01U.324.939**

### NDA-U-WMP Wall mount plate

Back plate for universal wall mount, corner mount and pole mount, white, IP66

Order number **NDA-U-WMP | F.01U.324.950**

### NDA-U-PMT Pendant pipe mount, 12" (31cm)

Universal pipe mount for dome cameras, 31 cm, white

Order number **NDA-U-PMT | F.01U.324.940**

### NDA-U-PMTE Pendant pipe extension, 20" (50cm)

Extension for universal pipe mount, 50 cm, white

Order number **NDA-U-PMTE | F.01U.324.941**



**NDA-U-PMTS Pendant pipe mount, 4" (11 cm)**

Universal pendant pipe mount for dome cameras, 11 cm (4"), white

Order number **NDA-U-PMTS | F.01U.385.046**

**NDA-U-PSMB Pendant wall/ceiling mount SMB**

Surface mount box (SMB) for wall mount or pipe mount.

Order number **NDA-U-PSMB | F.01U.324.942**

**NDA-U-PMAS Pole mount adapter small**

Pole mount adapter small

Universal pole mount adapter, white; small.

Order number **NDA-U-PMAS | F.01U.324.943**

**NDA-U-PMAL Pole mount adapter large**

Universal pole mount adapter, white; large

Order number **NDA-U-PMAL | F.01U.324.944**

**NDA-5080-PC Paintable cover, F360E, 4pcs**

Paintable cover FLEXIDOME panoramic 5100i IR

Order number **NDA-5080-PC | F.01U.394.004**

**NDA-5080-TM Tilt mount 20-deg, 148mm**

Tilt mount (20°) for FLEXIDOME IP 4000i / 5000i (IR) and FLEXIDOME panoramic 5100i IR camera families

Order number **NDA-5080-TM | F.01U.389.606**

**NDA-U-CBB Conduit back box, 148mm**

Outdoor conduit back box, 148mm, IP66 rated

Order number **NDA-U-CBB | F.01U.394.006**

**NDA-U-CMT Corner mount adapter**

Universal corner mount, white

Order number **NDA-U-CMT | F.01U.324.946**

**NDA-U-PMTG Pendant pipe mount, gang box**

Universal pipe mount, compatible with gang box installation for fixed dome cameras only, white

Order number **NDA-U-PMTG | F.01U.358.359**

**NDA-U-WMTG Pendant wall mount, gang box**

Universal wall mount, compatible with gang box installation for fixed dome cameras only, white

Order number **NDA-U-WMTG | F.01U.358.358**

**NPD-3001-WAP Portable installation tool**

Bosch camera portable and wireless installation tool

Order number **NPD-3001-WAP | F.01U.353.329**

**NPD-5001-POE Midspan, 15W, single port, AC in**

Power-over-Ethernet midspan injector for use with PoE enabled cameras; 15.4 W, 1-port

Weight: 200 g (0.44 lb)

Order number **NPD-5001-POE | F.01U.305.288**

**NPD-5004-POE Midspan, 4 port x 15W, AC in**

Power-over-Ethernet midspan injector for use with PoE enabled cameras; 15.4 W, 4-ports

Weight: 620 g (1.4 lb)

Order number **NPD-5004-POE | F.01U.305.289**

**VG4-SFPSCKT Ethernet to SFP interface kit**

Ethernet media converter video transmitter/data receiver fiber optic kit for AUTODOME 7000i cameras and for the Surveillance cabinets (NDA-U-PA0, NDA-U-PA1 and NDA-U-PA2).

Order number **VG4-SFPSCKT | F.01U.142.529**

**SFP-2 Fiber module, multimode, 1310nm, 2LC**

SFP Fiber Optic Module, 2 km (1.2 miles), 2 LC connectors.

Multi-mode

1310 nm

Order number **SFP-2 | F.01U.136.537**

**SFP-3 Fiber module, single-mode, 1310nm, 2LC**

SFP Fiber Optic Module, 20 km (12.4 miles), 2 LC connectors.

Single-mode

1310 nm

Order number **SFP-3 | F.01U.136.538**

**SFP-25 Fiber module, 1310/1550nm, 1SC**

SFP Fiber Optic Module, 2 km (1.2 miles), 1 SC connector

Multi-mode

1310/1550 nm

Order number **SFP-25 | F.01U.136.541**

**SFP-26 Fiber module, 1550/1310nm, 1SC**

SFP Fiber Optic Module, 2 km (1.2 miles), 1 SC connector

Multi-mode

1550/1310 nm

Order number **SFP-26 | F.01U.136.542**

**MSD-064G IP SECURITY MICROSD CARD 64GB**

64 GB industrial microSD card with health status monitoring

Order number **MSD-064G | F.01U.394.680**

**MSD-128G IP SECURITY MICROSD CARD 128GB**

128 GB industrial microSD card with health status monitoring

Order number **MSD-128G | F.01U.394.681**

**MSD-256G IP SECURITY MICROSD CARD 256GB**

256 GB industrial microSD card with health status monitoring

Order number **MSD-256G | F.01U.394.682**

**Software Options****MVC-IAA-TRIAL Trial License, 60-day**

Trial License, 60-day

Order number **MVC-IAA-TRIAL | F.01U.412.669**

**MVC-IAA-GUN1Y Gunshot Detector License, 1-year**

Gunshot Detector License, 1-year

Order number **MVC-IAA-GUN1Y | F.01U.412.670**

**MVC-IAA-GUN3Y Gunshot Detector License, 3-year**

Gunshot Detector License, 3-year

Order number **MVC-IAA-GUN3Y | F.01U.412.671**

**MVC-IAA-GUN5Y Gunshot Detector License, 5-year**

Gunshot Detector License, 5-year

Order number **MVC-IAA-GUN5Y | F.01U.412.672**

**MVC-IAA-GUN Gunshot Detector License, perpetual**

Gunshot Detector License, perpetual

Order number **MVC-IAA-GUN | F.01U.412.673**

**Represented by:**

**Europe, Middle East, Africa:**

Bosch Security Systems B.V.  
P.O. Box 80002  
5600 JB Eindhoven, The Netherlands  
Phone: + 31 40 2577 284  
[www.boschsecurity.com/xc/en/contact/](http://www.boschsecurity.com/xc/en/contact/)  
[www.boschsecurity.com](http://www.boschsecurity.com)

**Germany:**

Bosch Sicherheitssysteme GmbH  
Robert-Bosch-Ring 5  
85630 Grasbrunn  
Tel.: +49 (0)89 6290 0  
Fax: +49 (0)89 6290 1020  
[de.securitysystems@bosch.com](mailto:de.securitysystems@bosch.com)  
[www.boschsecurity.com](http://www.boschsecurity.com)

**North America:**

Bosch Security Systems, LLC  
130 Perinton Parkway  
Fairport, New York, 14450, USA  
Phone: +1 800 289 0096  
Fax: +1 585 223 9180  
[onlinehelp@us.bosch.com](mailto:onlinehelp@us.bosch.com)  
[www.boschsecurity.com](http://www.boschsecurity.com)

**Asia-Pacific:**

Robert Bosch (SEA) Pte Ltd, Security Systems  
11 Bishan Street 21  
Singapore 573943  
Phone: +65 6571 2808  
Fax: +65 6571 2699  
[www.boschsecurity.com/xc/en/contact/](http://www.boschsecurity.com/xc/en/contact/)  
[www.boschsecurity.com](http://www.boschsecurity.com)